

3GPP TR 36.800 V9.0.0 (2009-09)

Technical Report

**3rd Generation Partnership Project;
Technical Specification Group Radio Access Networks;
Universal Terrestrial Radio Access (UTRA)
and Evolved Universal Terrestrial Radio Access (E-UTRA);
Extended UMTS / LTE 800 Work Item Technical Report
(Release 9)**



The present document has been developed within the 3rd Generation Partnership Project (3GPPTM) and may be further elaborated for the purposes of 3GPP.

The present document has not been subject to any approval process by the 3GPP Organizational Partners and shall not be implemented. This Specification is provided for future development work within 3GPP only. The Organizational Partners accept no liability for any use of this Specification. Specifications and reports for implementation of the 3GPPTM system should be obtained via the 3GPP Organizational Partners' Publications Offices.

Keywords

UMTS, LTE, radio

3GPP

Postal address

3GPP support office address

650 Route des Lucioles - Sophia Antipolis
Valbonne - FRANCE
Tel.: +33 4 92 94 42 00 Fax: +33 4 93 65 47 16

Internet

<http://www.3gpp.org>

Copyright Notification

No part may be reproduced except as authorized by written permission.
The copyright and the foregoing restriction extend to reproduction in all media.

© 2009, 3GPP Organizational Partners (ARIB, ATIS, CCSA, ETSI, TTA, TTC).
All rights reserved.

UMTS™ is a Trade Mark of ETSI registered for the benefit of its members
3GPP™ is a Trade Mark of ETSI registered for the benefit of its Members and of the 3GPP Organizational Partners
LTE™ is a Trade Mark of ETSI currently being registered for the benefit of its Members and of the 3GPP Organizational Partners
GSM® and the GSM logo are registered and owned by the GSM Association

Contents

Foreword	5
1 Scope.....	6
2 References	6
3 Definitions, symbols and abbreviations	7
3.1 Definitions.....	7
3.2 Symbols.....	7
3.3 Abbreviations.....	7
4 Background	7
4.1 Task description.....	7
5 Study of UTRA Requirements	8
5.1 Co-existing with other technologies.....	8
5.2 Technical conditions for UTRA.....	8
5.3 Frequency bands and channel arrangement	8
5.3.1 Frequency bands.....	8
5.3.2 TX-RX frequency separation	8
5.3.3 Channel arrangement	9
5.3.3.1 Channel number	9
5.3.3.2 UARFCN	9
5.4 Specific UE RF requirements	9
5.4.1 Spurious emissions	9
5.4.1.1 General spurious emissions requirements	10
5.4.1.2 Additional spurious emissions requirements	10
5.4.2 Reference sensitivity level	10
5.4.2.1 Direction of investigation for UMTS.....	10
5.4.2.2 Evaluation of the reference sensitivity of Band XIX for UMTS.	10
5.4.2.3 Proposal of reference sensitivity of Band XIX for UMTS.....	12
5.4.3 Blocking characteristics	12
5.5 Specific signalling requirements considering dual band operation	12
6 Study of E-UTRA requirements	13
6.1 Co-existing with other technologies.....	13
6.2 Technical conditions for E-UTRA	13
6.2.1 Mandatory regulatory requirements:.....	13
6.2.2 Other technical conditions referred in Japan's regulations:	17
6.3 Operating bands and channel arrangement	20
6.3.1 Operating bands.....	20
6.3.2 TX-RX frequency separation.....	20
6.3.3 Channel arrangement	20
6.3.3.1 Carrier frequency and EARFCN	20
6.3.4 Channel bandwidths per operating band	21
6.4 Specific UE RF requirements	21
6.4.1 Maximum output power with additional requirements	21
6.4.1.1 Outline of evaluation method.....	21
6.4.1.2 Outline of Evaluation results.....	22
6.4.1.2.1 Brief overview of measurement results.....	22
6.4.1.2.2 for 5MHz Channel bandwidth cases	23
6.4.1.2.3 for 10MHz and 15MHz Channel bandwidth cases.....	23
6.4.1.3 Summary of results.....	24
6.4.2 Spurious emissions	24
6.4.2.1 Minimum requirements	25
6.4.2.2 Spurious emission band UE co-existence	25
6.4.2.3 Additional spurious emissions	25
6.4.3 Reference sensitivity power level	26
6.4.3.1 Direction of investigation for LTE	26

6.4.3.2	Evaluation of the reference sensitivity of Band 18 and Band 19 for LTE.....	26
6.4.3.3	Proposal of reference sensitivity of Band 18 and Band 19 for LTE	26
6.4.3.4	Evaluation of maximum uplink configuration of Band 18 and Band 19 for LTE	26
6.4.4	Blocking characteristics	27
6.4.4.1	In band blocking.....	27
6.4.4.2	Out of band blocking.....	27
6.5	E-UTRA Band 6 handling.....	27
7	Summary of required changes to UTRA specifications.....	27
7.1	Required changes to TS 25.101	27
7.2	Required changes to TS 25.104	28
7.3	Required changes to TS 25.113	28
7.4	Required changes to TS 25.133	29
7.5	Required changes to TS 25.141	29
7.6	Required changes to TS 34.124	30
7.7	Required changes to TS 25.306	30
7.8	Required changes to TS 25.307	30
7.9	Required changes to TS 25.331	30
7.10	Required changes to TS 25.461	30
7.11	Required changes to TS 25.466	31
7.12	Required changes to TS 34.108	31
7.13	Required changes to TS 34.121-1, TS34.121-2	31
7.14	Required changes to TS 34.123-1, TS 34.123-2, TS 34.123-3.....	32
8	Summary of required changes to E-UTRA specifications	32
8.1	Required changes to TS 36.101	32
8.2	Required changes to TS 36.104	33
8.3	Required changes to TS 36.113	33
8.4	Required changes to TS 36.124	33
8.5	Required changes to TS 36.133	34
8.6	Required changes to TS 36.141	34
8.7	Required changes to TS 36.331	34
8.8	Required changes to TS 36.508	34
8.9	Required changes to TS 36.521-1, TS 36.521-2, TS 36.521-3.....	35
8.10	Required changes to TS 36.523-1, TS 36.523-2, TS 36.523-3.....	35
9	Project plan.....	36
9.1	Schedule and Work Task Status.....	36
10	Open issues.....	36
Annex A:	UARFCN numbers.....	37
A.1	List of UARFCN used for UTRA FDD bands	37
Annex B:	Change history	40

Foreword

This Technical Report has been produced by the 3rd Generation Partnership Project (3GPP).

The contents of the present document are subject to continuing work within the TSG and may change following formal TSG approval. Should the TSG modify the contents of the present document, it will be re-released by the TSG with an identifying change of release date and an increase in version number as follows:

Version x.y.z

where:

- x the first digit:
 - 1 presented to TSG for information;
 - 2 presented to TSG for approval;
 - 3 or greater indicates TSG approved document under change control.
- y the second digit is incremented for all changes of substance, i.e. technical enhancements, corrections, updates, etc.
- z the third digit is incremented when editorial only changes have been incorporated in the document.

1 Scope

The present document is a technical report of the Extended UMTS/LTE 800 work item, which was established at TSG RAN#42. The objective of this work item is to provide UTRA and E-UTRA specification support for FDD in the Extended 800 MHz band in Japan. In addition to the schedule and status of the work items, the report includes a description of the motivation, requirements, study results and specification recommendations.

2 References

The following documents contain provisions which, through reference in this text, constitute provisions of the present document.

- References are either specific (identified by date of publication, edition number, version number, etc.) or non-specific.
- For a specific reference, subsequent revisions do not apply.
- For a non-specific reference, the latest version applies. In the case of a reference to a 3GPP document (including a GSM document), a non-specific reference implicitly refers to the latest version of that document *in the same Release as the present document*.

- [1] 3GPP TR 21.905: "Vocabulary for 3GPP Specifications".
- [2] R4-050618, "Frequency arrangement plan for IMT-2000 in the 800 MHz band in Japan" (ARIB), RAN4#36
- [3] RP-080884, "Work Item proposal for Extended UMTS/LTE 800 MHz band in Japan", RAN#42
- [4] R4-030687, "Summary of Partial Report on effective use of mobile commercial-use frequency in the 800Mhz-range in Japan" (ARIB), RAN4#28
- [5] R4-090023, "Technical conditions applied for extended LTE800 in Japan" (ARIB), RAN4#49bis
- [6] "(Partial report concerning effective use of mobile commercial-use frequency in the 800MHz-range)" [June.25, 2003] (Press release of MPHPT, in Japanese) http://www.soumu.go.jp/s-news/2003/030625_3.html
- [7] "(Executive summary of the Telecommunications Council, Technical committee #20)" [June.25, 2003] (in Japanese) http://www.soumu.go.jp/joho_tsusin/policyreports/joho_tsusin/bunkakai/030625_1.html
- [8] R4-051251 "Technical conditions of UE additional spurious emissions required in the 800MHz band in Japan," Fujitsu, Mitsubishi, NEC, NTT DoCoMo, Panasonic
- [9] R4-051420 "Revision of additional spurious emissions requirements on 800MHz band in Japan," Fujitsu, Mitsubishi, NEC, NTT DoCoMo, Panasonic
- [10] R4-051307 "Band VIII Rx sensitivity," Motorola
- [11] R4-080965 "UE Additional MPR (TP for TS36.101)," Fujitsu, NTT DoCoMo, Panasonic
- [12] R4-091380 "Further aspects on the harmonisation of the 800/850 bands," Ericsson

3 Definitions, symbols and abbreviations

3.1 Definitions

For the purposes of the present document, the terms and definitions given in TR 21.905 [1] and the following apply. A term defined in the present document takes precedence over the definition of the same term, if any, in TR 21.905 [1].

(void)

3.2 Symbols

For the purposes of the present document, the following symbols apply:

(void)

3.3 Abbreviations

For the purposes of the present document, the abbreviations given in TR 21.905 [1] and the following apply. An abbreviation defined in the present document takes precedence over the definition of the same abbreviation, if any, in TR 21.905 [1].

UE	User Equipment
BS	Base station
UL	Uplink (Reverse Link)
DL	Downlink (Forward Link)

4 Background

After the completion of intensive work in RAN4 for UMTS800 (Band VI), which was completed at December 2003, a commercial service in the 800MHz band, using UMTS Band VI, was launched in June 2005. As further informed in RAN4#36 in [2] as a frequency re-arrangement plan in 800MHz band of Japan before and beyond year of 2012, the lower part of the band (UL:815 - 830 MHz / DL:860 - 875 MHz) was allocated to cdma2000 and the upper part of the band (UL:830 - 845 MHz / DL:875 - 890 MHz) was allocated to UMTS.

Taking into account the latest frequency arrangement above, it is propose to introduce a new frequency band for UMTS.

As for LTE, Telecommunications Council of Japan started to study the possibility of introduction of LTE into the above both bands, which were allocated to cdma2000 and UMTS, and the detailed studies have been conducted by the working group under the council with the co-existence studies with the following technologies: UMTS, cdma2000, MCA system (ARIB standard RCR STD-23, 85).

Thus, the proponents of this work item believe that there is high possibility that not only UMTS but also LTE would be introduced in Japan in the band near future in order to enhance frequency efficiency. Accordingly corresponding necessary work to introduce new bands for LTE are also proposed.

4.1 Task description

The purpose of this work item is to:

4.1.1. Study of Extended UMTS/LTE 800 for a potential deployment in Japan. Generate a new technical report based on study results.

The specific bands to be studied are:

Band 18 for LTE:

815 - 830 MHz: UL

860 - 875 MHz: DL

Band XIX for UMTS/ Band 19 for LTE:

830 - 845 MHz: UL

875 - 890 MHz: DL

- 4.1.2 Generate CR's to update the appropriate documents
- 4.1.3 TSG RAN WG2 - study signalling issues related to Extended UMTS/LTE 800.
- 4.1.4 TSG RAN WG5 - study UE conformance testing issues related to Extended UMTS/LTE 800.
- 4.1.5 Any additional related issues.

The Work Item description for Extended UMTS/LTE 800 was approved in RAN#42 [3].

5 Study of UTRA Requirements

5.1 Co-existing with other technologies

As a result of the co-existing studies with the following technologies: PDC, MCA, Regional Disaster Prevention Radio (RDPR), the required guard bands between each system were lead in Telecommunications Council of Japan as provided in [4]. As further informed in RAN4#36 in [2] as a frequency re-arrangement plan in 800MHz band of Japan before and beyond year of 2012, the lower part of the band (UL:815 - 830 MHz / DL:860 - 875 MHz) was allocated to cdma2000 and the upper part of the band (UL:830 - 845 MHz / DL:875 - 890 MHz) was allocated to UMTS.

5.2 Technical conditions for UTRA

For Extended UMTS800, paired frequency band in 800MHz band and channel arrangement described in section 5.3 are used. Other than the frequency arrangement, technical conditions for UMTS800 (DS-CDMA800) [2] shall be applied.

5.3 Frequency bands and channel arrangement

5.3.1 Frequency bands

UTRA/FDD is designed to operate in the following paired bands:

Table 5.3-1: UTRA FDD frequency bands

Operating Band	UL Frequencies UE transmit, Node B receive	DL frequencies UE receive, Node B transmit
VI	830-840 MHz	875-885 MHz
XIV	788 – 798 MHz	758 – 768 MHz
XIX	830-845 MHz	875-890 MHz

5.3.2 TX-RX frequency separation

UTRA/FDD is designed to operate with the following TX-RX frequency separation

Table 5.3-2: TX-RX frequency separation

Operating Band	TX-RX frequency separation
VI	45 MHz
XIV	30 MHz
XIX	45 MHz

5.3.3 Channel arrangement

5.3.3.1 Channel number

The carrier frequency is designated by the UTRA Absolute Radio Frequency Channel Number (UARFCN). For Band XIX, the UARFCN values are defined as follows:

Uplink: $N_U = 5 * (F_{UL} - F_{UL_Offset})$, for the carrier frequency range $F_{UL_low} \leq F_{UL} \leq F_{UL_high}$

Downlink: $N_D = 5 * (F_{DL} - F_{DL_Offset})$, for the carrier frequency range $F_{DL_low} \leq F_{DL} \leq F_{DL_high}$

For Band XIX, F_{UL_Offset} , F_{UL_low} , F_{UL_high} , F_{DL_Offset} , F_{DL_low} and F_{DL_high} are defined in Table 5.3-3 for the general UARFCN. For the additional UARFCN, F_{UL_Offset} , F_{DL_Offset} and the specific F_{UL} and F_{DL} are defined in Table 5.3-4.

Table 5.3-3: UARFCN definition (general)

Band	UPLINK (UL) UE transmit, Node B receive			DOWNLINK (DL) UE receive, Node B transmit		
	UARFCN formula offset F_{UL_Offset} [MHz]	Carrier frequency (F_{UL}) range [MHz]		UARFCN formula offset F_{DL_Offset} [MHz]	Carrier frequency (F_{DL}) range [MHz]	
		F_{UL_low}	F_{UL_high}		F_{DL_low}	F_{DL_high}
VI	0	832.4	837.6	0	877.4	882.6
XIV	12	790.4	795.6	-63	760.4	765.6
XIX	770	832.4	842.6	735	877.4	887.6

Table 5.3-4: UARFCN definition (additional channels)

Band	UPLINK (UL) UE transmit, Node B receive		DOWNLINK (DL) UE receive, Node B transmit	
	UARFCN formula offset F_{UL_Offset} [MHz]	Carrier frequency [MHz] (F_{UL})	UARFCN formula offset F_{DL_Offset} [MHz]	Carrier frequency [MHz] (F_{DL})
VI	670.1	832.5, 837.5	670.1	877.5, 882.5
XIV	2.1	790.5, 795.5	-72.9	760.5, 765.5
XIX	755.1	832.5, 837.5, 842.5	720.1	877.5, 882.5, 887.5

5.3.3.2 UARFCN

The following UARFCN range shall be supported.

Table 5.3-5: UTRA Absolute Radio Frequency Channel Number

Band	Uplink (UL) UE transmit, Node B receive		Downlink (DL) UE receive, Node B transmit	
	General	Additional	General	Additional
VI	4162 to 4188	812, 837	4387 to 4413	1037, 1062
XIV	3892 to 3918	3942, 3967	4117 to 4143	4167, 4192
XIX	312 to 363	387, 412, 437	712 to 763	787, 812, 837

5.4 Specific UE RF requirements

5.4.1 Spurious emissions

This section shows the spurious emission requirements for UTRA Band XIX.

5.4.1.1 General spurious emissions requirements

The general spurious emissions requirements for Band XIX UEs are the same for other bands.

5.4.1.2 Additional spurious emissions requirements

In Japan, to introduce UMTS into the 800MHz band, where other cellular systems like cdmaOne has been operated simultaneously, required guard band width was investigated in the Telecommunications Council. As for the case where UMTS uplink may interfere with cdmaOne downlink, it was reported in [6] that 5MHz width would be needed as a guard band between those two systems for co-existence. Regarding the transmitter spurious emission from the UMTS UE to the interfered band, -36dBm/1.23MHz which power corresponds to -37dBm/1MHz was assumed for the above scenario [6][7]. According to the above study, the spurious emission requirements of Band VI were defined [8][9]. Since the above investigation was conducted for the frequency UL: 815-850MHz / DL: 860-895MHz, the same spurious emission requirement is applied to Band XIX as shown in Table 5.4.1.2-1.

Table 5.4.1.2-1 Additional spurious emissions requirements

Operating Band	Frequency Bandwidth	Measurement Bandwidth	Minimum requirement
VI	860 MHz ≤ f < 875 MHz	1 MHz	-37 dBm
	875 MHz ≤ f ≤ 895 MHz	3.84 MHz	-60 dBm
	1475.9 MHz ≤ f ≤ 1500.9 MHz	3.84 MHz	-60 dBm
	1844.9 MHz ≤ f ≤ 1879.9 MHz	3.84 MHz	-60 dBm
	1884.5 MHz ≤ f ≤ 1919.6 MHz	300 kHz	-41 dBm
	2110 MHz ≤ f ≤ 2170 MHz	3.84 MHz	-60 dBm
XIX	860 MHz ≤ f < 875 MHz	1 MHz	-37 dBm
	875 MHz ≤ f ≤ 895 MHz	3.84 MHz	-60 dBm
	1475.9 MHz ≤ f ≤ 1500.9 MHz	3.84 MHz	-60 dBm
	1844.9 MHz ≤ f ≤ 1879.9 MHz	3.84 MHz	-60 dBm
	1884.5 MHz ≤ f ≤ 1919.6 MHz	300 kHz	-41 dBm
	2110 MHz ≤ f ≤ 2170 MHz	3.84 MHz	-60 dBm

5.4.2 Reference sensitivity level

5.4.2.1 Direction of investigation for UMTS

The relation between Band XIX and the existence Band V and Band VI is illustrated in Figure 5.4.2.1-1. It can be observed that Band V includes Band XIX. On the other hand, since the UEs implementing the duplexer to support both Band VI and V have already been used in UMTS, we first use this UMTS UEs to evaluate the reference sensitivity of Band XIX.

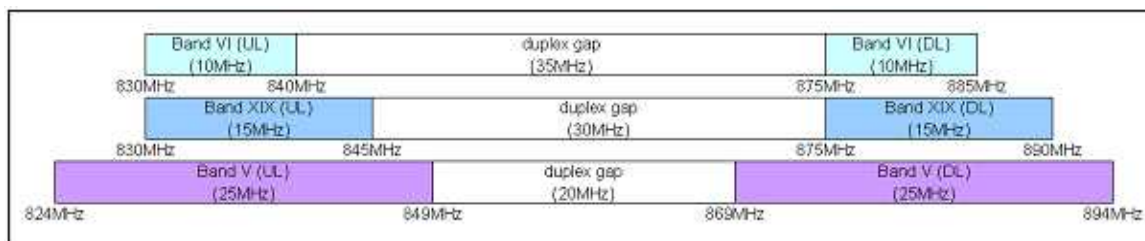

Figure 5.4.2.1-1 Frequency arrangement for Band VI, Band XIX and Band V

5.4.2.2 Evaluation of the reference sensitivity of Band XIX for UMTS.

We have measured the reference sensitivity of Band XIX using 12 different kinds of UMTS UE models with the duplexer supports both Band VI and Band V. The measurements were conducted at normal temperature condition. Measurement points and corresponding results are shown in Figure 5.4.2.2-1 and Table 5.4.2.2-1 respectively.

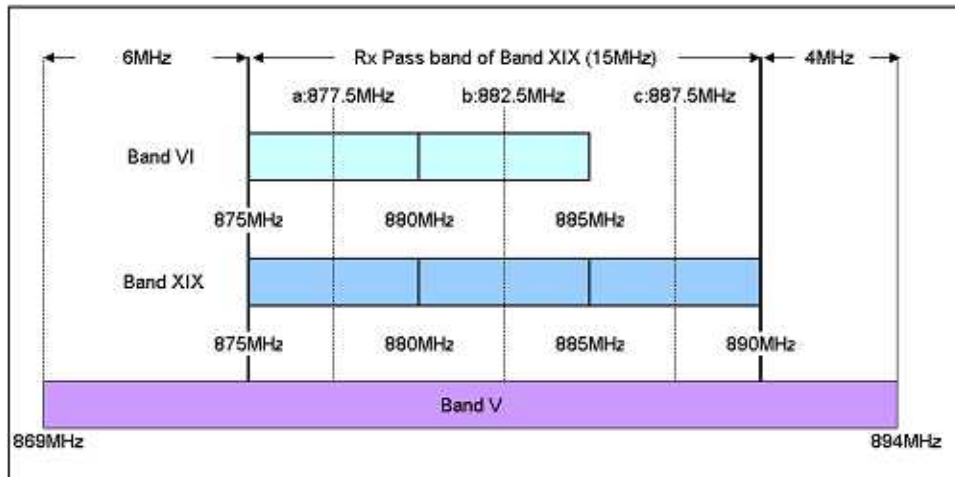

Figure 5.4.2-1 Measurement points of the reference sensitivity of Band XIX

Table 5.4.2.2-1 Measurement results of the reference sensitivity

model	Reference sensitivity DPCH_Ec (dBm/3.84MHz)			-117dBm/3.84MHz*1 - each result (dB)		
	A	B	c	A	b	c
	877.5MHz	882.5MHz	887.5MHz	877.5MHz	882.5MHz	887.5MHz
A	-122.0	-121.9	-121.8	5.0	4.9	4.8
B	-121.1	-121.3	-121.0	4.1	4.3	4.0
C	-121.8	-121.8	-122.0	4.8	4.8	5.0
D	-121.7	-122.0	-121.8	4.7	5.0	4.8
E	-120.6	-120.4	-120.3	3.6	3.4	3.3
F	-120.7	-120.8	-120.7	3.7	3.8	3.7
G	-122.1	-122.1	-122.1	5.1	5.1	5.1
H	-122.2	-122.2	-121.8	5.2	5.2	4.8
I	-121.0	-120.9	-120.7	4.0	3.9	3.7
J	-123.0	-122.8	-122.5	6.0	5.8	5.5
K	-119.3	-119.3	-119.5	2.3	2.3	2.5
L	-119.9	-120.0	-120.2	2.9	3.0	3.2
Min	-119.3	-119.3	-119.5	2.3	2.3	2.5
Max	-123.0	-122.8	-122.5	6.0	5.8	5.5
average	-121.3	-121.3	-121.2	4.3	4.3	4.2

*1: The reference sensitivity level of Band I, IV, VI, and X for UMTS in TS 25.101

From the results, it can be seen that at test point (a) and (b), all UEs meet the reference sensitivity requirement - 117dBm/3.84MHz for Band VI. It can be also observed that at test point (c), all UEs also meet Band VI requirement with at least 2.3dB margins. Moreover, the differences between point (c) and other 2 points are extremely small.

In addition, for "K" UE which indicated the lowest reference sensitivity in this test, additional measurements were conducted to confirm the characteristic variation with the 9 different "K" UEs as shown in Table 5.4.2.2-2.

Table 5.4.2.2-2 Measurement results of the reference sensitivity of "K"

model "K"	Reference sensitivity DPCH_Ec (dBm/3.84MHz)	-117dBm/3.84MHz*1 - each result (dB)
--------------	--	--------------------------------------

	A	B	c	A	b	c
	877.5MHz	882.5MHz	887.5MHz	877.5MHz	882.5MHz	887.5MHz
reference	-119.3	-119.3	-119.5	2.3	2.3	2.5
1	-120.2	-120.5	-120.3	3.2	3.5	3.3
2	-120.6	-120.6	-120.4	3.6	3.6	3.4
3	-120.4	-120.6	-120.1	3.4	3.6	3.1
4	-120.4	-120.5	-120.2	3.4	3.5	3.2
5	-120.5	-120.5	-120.3	3.5	3.5	3.3
6	-120.4	-120.3	-120.4	3.4	3.3	3.4
7	-120.3	-120.6	-120.4	3.3	3.6	3.4
8	-120.6	-120.2	-120.1	3.6	3.2	3.1
9	-120.1	-120.4	-120.3	3.1	3.4	3.3
Min	-119.3	-119.3	-119.5	2.3	2.3	2.5
Max	-120.6	-120.6	-120.4	3.6	3.6	3.4
average	-120.4	-120.5	-120.3	3.4	3.5	3.3

It can be seen that the first measurement result was the worst case. Therefore, it can be concluded that the Band XIX UEs implementing the current duplexer supporting Band VI and Band V can sufficiently satisfy the requirement of Band VI over the frequency range 875-890MHz of Band XIX even when the filter temperature shift is considered [10].

5.4.2.3 Proposal of reference sensitivity of Band XIX for UMTS

From the above analysis, it can be seen that the UEs implementing the duplexer for UMTS Band VI and Band V can satisfy Band VI requirement over the whole frequency range of extended Band XIX in both normal temperature and with the filter temperature shift. Therefore, we propose to apply the same reference sensitivity requirement of Band VI for Band XIX. The proposed requirements for TS25.101 are summarized in Table 5.4.2.3-1.

Table 5.4.2.3-1 Reference sensitivity for UMTS

Operating Band	Unit	DPCH_Ec <REFSENS>	<REFI _{or} >
VI	dBm/3.84 MHz	-117	-106.7
XIX	dBm/3.84 MHz	-117	-106.7

5.4.3 Blocking characteristics

In-band blocking and Out-of-band blocking requirements for Extended UMTS 800 (Band XIX) should apply the same requirements for other band.

5.5 Specific signalling requirements considering dual band operation

The commercial service in Band VI, was launched in June 2005. After the completion of the work for the new Band XIX for UMTS, commercial UMTS service will be launched in the near future in Japan. However, in order to support the existing legacy UE which has the capability for only Band VI, the band indicator and the UARFCN must be set as "Band VI" and "UTRA Band XIX" in the DL frequency range of 875-885 MHz and 885-890 MHz, respectively in UTRAN as shown in Figure 5.5-1.

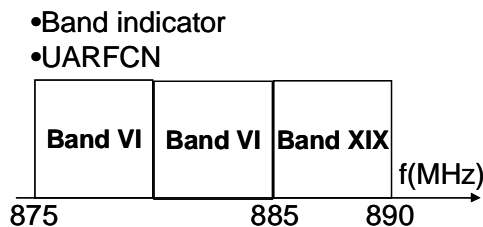

Figure 5.5-1 Assumed Band indicator and UARFCN settings in UTRAN

Although the band plan of the new UTRA Band XIX is completely overlapping with that of Band VI, the difference in supported frequency range is only 5MHz in UL/DL each. Therefore, many UE RF requirements will be implicitly identical between Band VI and the new Band XIX. One of the corresponding requirements is UE reference sensitivity level. However, if the new UTRA Band XIX UE does not have the Band VI capability, the UE consider the cell which operated as Band VI to be barred. Therefore, considering (1) implicitly identical UE RF requirements between Band VI and the new UTRA Band XIX and (2) the above problem under the dual band operation, UTRA Band XIX UE should have the radio access capability of both Band VI and UTRA Band XIX.

6 Study of E-UTRA requirements

6.1 Co-existing with other technologies

Telecommunications Council of Japan started to study the possibility of introduction of LTE into the above both bands, which were allocated to cdma2000 and UMTS, and the detailed studies have been conducted by the working group under the council with the co-existence studies with the following technologies: UMTS, cdma2000, MCA system. As a result of this study, technical condition of E-UTRA was lead as provided in [5].

6.2 Technical conditions for E-UTRA

The technical conditions for extended LTE 800 were derived based on the requirements for 800MHz band (E-UTRA Band 6). Necessary changes such as the frequency arrangement or spurious emission requirements were made. Those changes and its rationale are summarized in the following sub sections. Revised parts compared with requirements for Band 6 are colored yellow and underlined>.

6.2.1 Mandatory regulatory requirements:

(a) Frequency arrangement:

The frequency band for extended LTE800 in Japan is as follows:

UL: 815MHz - 845MHz (Band 18 : 815 – 830MHz, Band 19 : 830 – 845MHz)

DL: 860MHz - 890MHz (Band 18 : 860 – 875MHz, Band 19 : 875 – 890MHz).

Tx-Rx frequency separation: 45MHz

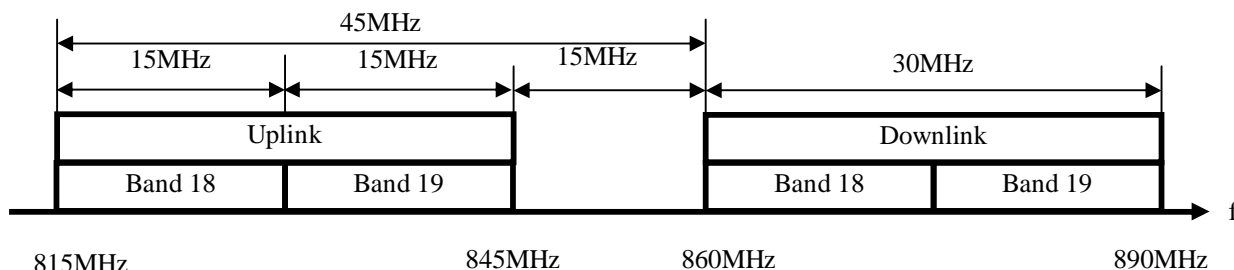

Figure 6.2.1: Frequency band for extended LTE800**(b) Frequency error:**

Frequency error requirements for extended LTE800 are specified same as other Bands shown following;

BS: The modulated carrier frequency of the BS shall be accurate to within $\pm (0.05\text{ppm}+12\text{Hz})$.

UE: The UE modulated carrier frequency shall be accurate to within $\pm (0.1 \text{ ppm}+15\text{Hz})$ compared to the carrier frequency received from the eNode B.

(c) Spurious emissions:

Spurious emissions requirements for extended LTE800 are specified as in Table 6.2.1.

Table 6.2.1: Spurious emission requirements for extended LTE800

Parameter	Requirement	
Spurious emissions limits	BS	
	Table 6.2.1-1 Spurious emissions limits for extended LTE800 BS	
	Frequency range	Maximum level
	9kHz – 150kHz	-13dBm/1kHz
	150kHz – 30MHz	-13dBm/10kHz
	30MHz – 1000MHz	-13dBm/100kHz
	1000MHz – 12.75GHz	-13dBm/1MHz
	The requirements are only applicable for frequencies, which are greater than 10 MHz away from the BS transmitter operating band edge.	
	Table 6.2.1-2 Additional spurious emission limits for extended LTE800 BS	
	Frequency range	Maximum level
1884.5MHz – 1919.6MHz	-41dBm/300kHz *	
2010MHz – 2025MHz	-52dBm/1MHz	
* The requirement is applicable even if the frequencies are lesser than 10MHz away from the BS transmitter operating band edge.		
UE	The requirements below are only applicable for frequencies, which are greater than 12.5 MHz away from the UE centre carrier frequency for 5MHz LTE system. Likewise, greater than 20MHz for 10MHz LTE system, greater than 27.5MHz for 15MHz LTE system and greater than 35MHz for 20MHz LTE system.	
Table 6.2.1-3 Spurious emission limits for extended LTE800 UE		
Frequency range	Maximum level	
9kHz – 150kHz	-36dBm/1kHz	
150kHz – 30MHz	-36dBm/10kHz	
30MHz – 1000MHz	-36dBm/100kHz	
1000MHz – 12.75GHz	-30dBm/1MHz	
Table 6.2.1-4 Additional spurious emission limits for extended LTE800 UE		
Frequency range	Maximum level	
860MHz – 895MHz	-40dBm/1MHz*	
1475.9MHz – 1500.9MHz	-50dBm/1MHz	
1844.9MHz – 1879.9MHz	-50dBm/1MHz	
1884.5MHz – 1919.6MHz	-41dBm/300kHz	
2010MHz – 2025MHz	-50dBm/1MHz	
2110MHz – 2170MHz	-50dBm/1MHz	
* This requirement also applies for the frequency ranges that are less than the above frequency assumption.		

(d) Adjacent Channel Leakage power Ratio (ACLR):

Adjacent Channel Leakage power Ratio (ACLR) requirements for extended LTE800 are specified same as other Bands shown following;

Table 6.2.2: ACLR requirements for extended LTE800

Requirement																																												
BS	Either the ACLR limits in the Table 6.2.2-1 below or the absolute limit of -13dBm/MHz apply, whichever is less stringent. Table 6.2.2-1 ACLR for extended LTE800 BS																																											
	<table border="1"> <thead> <tr> <th>System</th> <th>Frequency separation</th> <th>ACLR limit</th> <th>Measurement bandwidth</th> </tr> </thead> <tbody> <tr> <td rowspan="4">5MHz</td> <td>5MHz</td> <td>-44.2dBc</td> <td>4.5MHz</td> </tr> <tr> <td>10MHz</td> <td>-44.2dBc</td> <td>4.5MHz</td> </tr> <tr> <td>5MHz</td> <td>-44.2dBc</td> <td>3.84MHz</td> </tr> <tr> <td>10MHz</td> <td>-44.2dBc</td> <td>3.84MHz</td> </tr> <tr> <td rowspan="4">10MHz</td> <td>10MHz</td> <td>-44.2dBc</td> <td>9MHz</td> </tr> <tr> <td>20MHz</td> <td>-44.2dBc</td> <td>9MHz</td> </tr> <tr> <td>7.5MHz</td> <td>-44.2dBc</td> <td>3.84MHz</td> </tr> <tr> <td>12.5MHz</td> <td>-44.2dBc</td> <td>3.84MHz</td> </tr> <tr> <td rowspan="4">15MHz</td> <td>15MHz</td> <td>-44.2dBc</td> <td>13.5MHz</td> </tr> <tr> <td>30MHz</td> <td>-44.2dBc</td> <td>13.5MHz</td> </tr> <tr> <td>10MHz</td> <td>-44.2dBc</td> <td>3.84MHz</td> </tr> <tr> <td>15MHz</td> <td>-44.2dBc</td> <td>3.84MHz</td> </tr> </tbody> </table>	System	Frequency separation	ACLR limit	Measurement bandwidth	5MHz	5MHz	-44.2dBc	4.5MHz	10MHz	-44.2dBc	4.5MHz	5MHz	-44.2dBc	3.84MHz	10MHz	-44.2dBc	3.84MHz	10MHz	10MHz	-44.2dBc	9MHz	20MHz	-44.2dBc	9MHz	7.5MHz	-44.2dBc	3.84MHz	12.5MHz	-44.2dBc	3.84MHz	15MHz	15MHz	-44.2dBc	13.5MHz	30MHz	-44.2dBc	13.5MHz	10MHz	-44.2dBc	3.84MHz	15MHz	-44.2dBc	3.84MHz
	System	Frequency separation	ACLR limit	Measurement bandwidth																																								
	5MHz	5MHz	-44.2dBc	4.5MHz																																								
		10MHz	-44.2dBc	4.5MHz																																								
		5MHz	-44.2dBc	3.84MHz																																								
		10MHz	-44.2dBc	3.84MHz																																								
	10MHz	10MHz	-44.2dBc	9MHz																																								
		20MHz	-44.2dBc	9MHz																																								
		7.5MHz	-44.2dBc	3.84MHz																																								
		12.5MHz	-44.2dBc	3.84MHz																																								
	15MHz	15MHz	-44.2dBc	13.5MHz																																								
		30MHz	-44.2dBc	13.5MHz																																								
		10MHz	-44.2dBc	3.84MHz																																								
		15MHz	-44.2dBc	3.84MHz																																								
UE	The adjacent channel power shall be less than or equal to -50 dBm/ 4.5MHz (5MHz system) or -50 dBm/ 9MHz (10MHz system) or -50 dBm/ 13.5MHz (15MHz system) or -50 dBm/ 3.84MHz (3.84MHz system) or as specified by the ACLR limit in the Table 6.2.2-2, whichever is the higher. Table 6.2.2-2 ACLR for extended LTE800 UE																																											
	<table border="1"> <thead> <tr> <th>System</th> <th>Frequency separation</th> <th>ACLR limit</th> <th>Measurement bandwidth</th> </tr> </thead> <tbody> <tr> <td rowspan="3">5MHz</td> <td>5MHz</td> <td>-29.2dBc</td> <td>4.5MHz</td> </tr> <tr> <td>5MHz</td> <td>-32.2dBc</td> <td>3.84MHz</td> </tr> <tr> <td>10MHz</td> <td>-35.2dBc</td> <td>3.84MHz</td> </tr> <tr> <td rowspan="3">10MHz</td> <td>10MHz</td> <td>-29.2dBc</td> <td>9MHz</td> </tr> <tr> <td>7.5MHz</td> <td>-32.2dBc</td> <td>3.84MHz</td> </tr> <tr> <td>12.5MHz</td> <td>-35.2dBc</td> <td>3.84MHz</td> </tr> <tr> <td rowspan="3">15MHz</td> <td>15MHz</td> <td>-29.2dBc</td> <td>13.5MHz</td> </tr> <tr> <td>10MHz</td> <td>-32.2dBc</td> <td>3.84MHz</td> </tr> <tr> <td>15MHz</td> <td>-35.2dBc</td> <td>3.84MHz</td> </tr> </tbody> </table>	System	Frequency separation	ACLR limit	Measurement bandwidth	5MHz	5MHz	-29.2dBc	4.5MHz	5MHz	-32.2dBc	3.84MHz	10MHz	-35.2dBc	3.84MHz	10MHz	10MHz	-29.2dBc	9MHz	7.5MHz	-32.2dBc	3.84MHz	12.5MHz	-35.2dBc	3.84MHz	15MHz	15MHz	-29.2dBc	13.5MHz	10MHz	-32.2dBc	3.84MHz	15MHz	-35.2dBc	3.84MHz									
	System	Frequency separation	ACLR limit	Measurement bandwidth																																								
	5MHz	5MHz	-29.2dBc	4.5MHz																																								
		5MHz	-32.2dBc	3.84MHz																																								
		10MHz	-35.2dBc	3.84MHz																																								
	10MHz	10MHz	-29.2dBc	9MHz																																								
		7.5MHz	-32.2dBc	3.84MHz																																								
		12.5MHz	-35.2dBc	3.84MHz																																								
	15MHz	15MHz	-29.2dBc	13.5MHz																																								
10MHz		-32.2dBc	3.84MHz																																									
15MHz		-35.2dBc	3.84MHz																																									

ACLR limits include the test tolerance which is specified in TS36.141 and TS36.521-1.

(e) Spectrum emission mask:

Spectrum emission mask for extended LTE800 are specified same as other Bands shown following;

BS: Spectrum emission mask requirements for extended LTE800 are specified as in Table 6.2.3.

UE: Spectrum emission mask requirements for extended LTE800 are specified as in Table 6.2.4.

Spectrum emission mask requirements include the test tolerance which is specified in TS36.141 and TS36.521-1.

Table 6.2.3: Spectrum emission mask requirements for extended LTE800 BS

Δf in MHz (Note)	Requirement	Measurement bandwidth
$0.05 \leq \Delta f < 5.05$	-5.5dBm-7/5X(Δf -0.05)dB	100 kHz
$5.05 \leq \Delta f < 10.05$	-12.5dBm	100 kHz
$10.05 \leq \Delta f$	-13dBm	100 kHz

(Note) Δf is offset frequency from edge of channel bandwidth.

Table 6.2.4: Spectrum emission mask requirements for extended LTE800 UE

Δf in MHz	Requirement (dBm)			Measurement bandwidth
	5MHz system	10MHz system	15MHz system	
$0 \leq \Delta f < 1$	-13.5	-16.5	-18.5	30 kHz
$1 \leq \Delta f < 2.5$	-8.5	-8.5	-8.5	1 MHz
$2.5 \leq \Delta f < 5$	-8.5	-8.5	-8.5	1 MHz
$5 \leq \Delta f < 6$	-11.5	-11.5	-11.5	1 MHz
$6 \leq \Delta f < 10$	-23.5	-11.5	-11.5	1 MHz
$10 \leq \Delta f < 15$		-23.5	-11.5	1 MHz
$15 \leq \Delta f < 20$			-23.5	1 MHz

(f) Occupied bandwidth:

Occupied bandwidth for extended LTE800 are specified same as other Bands shown following;

BS: The occupied channel bandwidth shall be less than 5 MHz (5MHz system) or 10MHz (10MHz system) or 15MHz (15MHz system).

UE: The occupied channel bandwidth shall be less than 5 MHz (5MHz system) or 10MHz (10MHz system) or 15MHz (15MHz system).

(g) Maximum output power

Maximum output power for extended LTE800 are specified same as other Bands shown following;

BS: In normal conditions, the Base station maximum output power shall remain within +2.7dB and -2.7dB of the manufacturer's rated output power.

UE: The UE maximum output power is defined 23dBm. In normal conditions, the UE maximum output power shall remain within +2.7dB and -2.7dB of the defined output power.

(h) Transmit OFF power

Transmit OFF power for extended LTE800 are specified same as other Bands shown following;

BS: Not specified.

UE: Spectrum emission mask requirements for extended LTE800 are specified as in Table 6.2.5.

Table 6.2.5: Transmit OFF power requirements for extended LTE800 UE

Channel bandwidth	Transmit OFF power	Measurement bandwidth
5MHz	-48.5dBm	4.5 MHz
10MHz	-48.5dBm	9 MHz
15MHz	-48.5dBm	13.5 MHz

Transmit OFF power requirements include the test tolerance which is specified in TS36.521-1.

(i) Transmit Intermodulation

Transmit Intermodulation for extended LTE800 are specified same as other Bands shown following;

BS: The transmit intermodulation level is the power of the intermodulation products when a LTE modulated interference signal is injected into the antenna connector at a mean power level of 30 dB lower than that of the mean power of the wanted signal. The occupied bandwidth for the interference signal is specified as 5MHz. The frequency of the interference signal shall be ± 5 MHz, ± 10 MHz, ± 15 MHz (5MHz system), ± 7.5 MHz, ± 12.5 MHz, ± 17.5 MHz (10MHz system) , ± 10 MHz, ± 15 MHz, ± 20 MHz (15MHz system) offset from the subject signal carrier frequency. The transmitter intermodulation level shall not exceed the out of band emission or spectrum emission mask or the spurious emission requirements.

UE: Not specified.

(j) Receiver Spurious emissions:

Receiver Spurious emissions requirements for extended LTE800 are specified as in Table 6.2.6.

Table 6.2.6: Receiver Spurious emission requirements for extended LTE800

Parameter		Requirement	
Receiver spurious emissions limits	BS	Table 6.2.6-1 Receiver spurious emission limits for extended LTE800 BS	
		Frequency range	Maximum level
		30MHz – 1000MHz	-57dBm/100kHz*
		1GHz – 12.75GHz	-47dBm/1MHz
		2010MHz – 2025MHz	-52dBm/1MHz
	*With the exception of frequencies between 850 MHz and 905MHz.		
UE	Table 6.2.6-2 Receiver spurious emissions limits for extended LTE800 UE		
	Frequency range	Maximum level	
	30MHz – 1000MHz	-57dBm/100kHz	
	1GHz – 12.75GHz	-47dBm/1MHz	

6.2.2 Other technical conditions referred in Japan's regulations:

(a) Reference sensitivity level

(i) BS

The reference sensitivity level is -100.8dBm. This requirement is applied with a width of 25 resource blocks each for each channel BW. The reference sensitivity level includes the test tolerance which is specified in TS36.141.

(ii) UE

The reference sensitivity level for extended LTE800 is set as:

Table 6.2.7: UE reference sensitivity levels

Channel BW	UE reference sensitivity level (dBm)
5MHz	-99.3
10MHz	-96.3
15MHz	-94.5

The UE sensitivity level is set same values as that of band 6 for extended LTE800 in the case of 5MHz and 10MHz channel bandwidth. In the case of 15MHz channel bandwidth, considering extended LTE800 by 5MHz channel bandwidth and Table 7.3.1-1 in TS 36.101, -94.5dBm is set. Then, these values are 0.7dB different from TS 36.101 because these values include the test tolerance (0.7dB) which is specified in TS36.521-1.

(b) Adjacent Channel Selectivity (ACS)

(i) BS

With the conditions described in Table 6.2.8, the throughput shall not fall below 95 percent of the maximum throughput.

Table 6.2.8: Test conditions for Adjacent channel selectivity

Parameter	Channel bandwidth			Unit
	5MHz	10MHz	15MHz	
Propagation condition	Static			-
Interfering signal characteristic	QPSK, code rate:1/3			-
Wanted signal mean power	<REFSENS>+6			dBm
Interfering signal mean power	-52	-52	-52	dBm
Few offset (Modulated)	5	7.5	10	MHz

(ii) UE

With the conditions described in Table 6.2.9, the throughput shall not fall below 95 percent of the maximum throughput.

Table 6.2.9: Test conditions for Adjacent Channel Selectivity

Parameter	Channel bandwidth			Unit
	5MHz	10MHz	15MHz	
Propagation condition	Static			-
Interfering signal characteristic	QPSK, code rate:1/3			-
Wanted signal mean power	<REFSENS>+14			dBm
Interfering signal mean power	<REFSENS> +45.5	<REFSENS> +45.5	<REFSENS> +42.5	dBm
Few offset (Modulated)	5	7.5	10	MHz

(c) Blocking

(i) BS

With the conditions described in Table 6.2.10, the throughput shall not fall below 95 percent of the maximum throughput.

Table 6.2.10: Test conditions for Blocking

Parameter	Channel bandwidth			Unit
	5MHz	10MHz	15MHz	
Propagation condition	Static			-
Interfering signal characteristic	QPSK, code rate:1/3			-
Wanted signal mean power	<REFSENS>+6			dBm
Interfering signal mean power	-43	-43	-43	dBm
Few offset (Modulated)	10	12.5	15	MHz

(ii) UE

With the conditions described in Table 6.2.11, the throughput shall not fall below 95 percent of the maximum throughput.

Table 6.2.11: Test conditions for Blocking

Parameter		Channel bandwidth			Unit
		5MHz	10MHz	15MHz	
Propagation condition		Static			-
Interfering signal characteristic		QPSK, code rate:1/3			-
Wanted signal mean power		<REFSENS>+6			dBm
Case 1	Interfering signal mean power	-56	-56	-56	dBm
	Few offset (Modulated)	10	12.5	15	MHz
	Bandwidth	5	5	5	MHz
Case 2	Interfering signal mean power	-44	-44	-44	dBm
	Few offset (Modulated)	15	17.5	20	MHz
	Bandwidth	5	5	5	MHz

(d) Intermodulation characteristics**(i) BS**

With the conditions described in Table 6.2.12, the throughput shall not fall below 95 percent of the maximum throughput.

Table 6.2.12: Test conditions for Intermodulation characteristics

Parameter		Channel bandwidth			Unit
		5MHz	10MHz	15MHz	
Propagation condition		Static			-
Wanted signal mean power		<REFSENS>+6			dBm
Interfering signal 1	Characteristic	Current wave			-
	Mean power	-52			dBm
	Fuw offset (CW)	10	12.5	15	MHz
Interfering signal 2	Characteristic	Modulation wave			-
	Bandwidth	5			MHz
	Mean power	-52			dBm
	Fuw offset (Modulated)	20	22.7	25.5	MHz

(ii) UE

With the conditions described in Table 6.2.13, the throughput shall not fall below 95 percent of the maximum throughput.

Table 6.2.13: Test conditions for Intermodulation characteristics

Parameter		Channel bandwidth			Unit
		5MHz	10MHz	15MHz	
Propagation condition		Static			-
Wanted signal mean power		<REFSENS>+6		<REFSENS>+7	dBm
Interfering signal 1	Characteristic	Current wave			-
	Mean power	-46			dBm
	Fuw offset (CW)	10	12.5	15	MHz
Interfering signal 2	Characteristic	Modulation wave			-
	Bandwidth	5			MHz
	Mean power	-46			dBm
	Fuw offset (Modulated)	20	25	30	MHz

6.3 Operating bands and channel arrangement

6.3.1 Operating bands

E-UTRA is designed to operate in the operating bands defined in Table 6.3-1.

Table 6.3-1 E-UTRA operating bands

EUTRA Operating Band	Uplink (UL) operating band BS receive UE transmit			Downlink (DL) operating band BS transmit UE receive			Duplex Mode
	F_{UL_low}	–	F_{UL_high}	F_{DL_low}	–	F_{DL_high}	
6	830 MHz	–	840 MHz	875 MHz	–	885 MHz	FDD
17	704 MHz	–	716 MHz	734 MHz	–	746 MHz	FDD
18	815 MHz	–	830 MHz	860 MHz	–	875 MHz	FDD
19	830 MHz	–	845 MHz	875 MHz	–	890 MHz	FDD
...							
33	1900 MHz	–	1920 MHz	1900 MHz	–	1920 MHz	TDD

6.3.2 TX–RX frequency separation

a) The default E-UTRA TX channel (carrier centre frequency) to RX channel (carrier centre frequency) separation is specified in Table 6.3-2 for the TX and RX channel bandwidths defined in Table 6.3-1

Table 6.3-2: Default UE TX-RX frequency separation

Frequency Band	TX - RX carrier centre frequency separation
6	45 MHz
17	30 MHz
18	45 MHz
19	45 MHz

6.3.3 Channel arrangement

6.3.3.1 Carrier frequency and EARFCN

The carrier frequency in the uplink and downlink is designated by the E-UTRA Absolute Radio Frequency Channel Number (EARFCN) in the range 0 - 65535. The relation between EARFCN and the carrier frequency in MHz for the downlink is given by the following equation, where F_{DL_low} and $N_{Offs-DL}$ are given in table 6.3-3 and N_{DL} is the downlink EARFCN.

$$F_{DL} = F_{DL_low} + 0.1(N_{DL} - N_{Offs-DL})$$

The relation between EARFCN and the carrier frequency in MHz for the uplink is given by the following equation where F_{UL_low} and $N_{Offs-UL}$ are given in table 6.3-3 and N_{UL} is the uplink EARFCN.

$$F_{UL} = F_{UL_low} + 0.1(N_{UL} - N_{Offs-UL})$$

Table 6.3-3 E-UTRA channel numbers

E-UTRA Operating Band	Downlink			Uplink		
	F_{DL_low} (MHz)	$N_{Offs-DL}$	Range of N_{DL}	F_{UL_low} (MHz)	$N_{Offs-UL}$	Range of N_{UL}
6	875	2650	2650 – 2749	830	20650	20650 – 20749
17	734	5730	5730 – 5849	704	23730	23730 - 23849
18	860	5850	5850 – 5999	815	23850	23850 – 23999
19	875	6000	6000 – 6149	830	24000	24000 – 24149
...						
33	1900	26000	36000 – 36199	1900	36000	36000 – 36199

6.3.4 Channel bandwidths per operating band

The requirements in this specification apply to the combination of channel bandwidths and operating bands shown in Table 6.3-4. The transmission bandwidth configuration in Table 6.3-4 shall be supported for each of the specified channel bandwidths. The same (symmetrical) channel bandwidth is specified for both the TX and RX path.

Table 6.3-4: E-UTRA channel bandwidth

E-UTRA band / channel bandwidth						
E-UTRA Band	1.4 MHz	3 MHz	5 MHz	10 MHz	15 MHz	20 MHz
6			Yes	Yes ^[1]		
17	Yes	Yes	Yes ^[1]	Yes ^[1]		
18			Yes	Yes ^[1]	Yes ^[1]	
19			Yes	Yes ^[1]	Yes ^[1]	
...						
33			Yes	Yes	Yes	Yes

NOTE 1: bandwidth for which a relaxation of the specified UE receiver sensitivity requirement (Section 6.4.3) is allowed.

6.4 Specific UE RF requirements

6.4.1 Maximum output power with additional requirements

6.4.1.1 Outline of evaluation method

To evaluate proper A-MPR to satisfy the above spurious emission requirements, measurements on leakage interference power were actually conducted under the test conditions as shown in Table 6.4.1.1-1 which are basically based on [11]. The measurement procedures are summarized below. It should be noted that unless otherwise stated, some certain implementation margins are incorporated in the measurement results.

1. For each Channel bandwidth, the largest transmission resource blocks (RBs) are constantly assigned at the upper edge of the transmission band.
2. UE UL power is reduced in one dB step until the additional spurious emission requirements are satisfied.
3. After satisfying the spurious emission requirements, then, RBs are reduced.
4. The steps 1 to 3 are repeated until the A-MPR is not needed for each Channel bandwidth.

Table 6.4.1.1-1 Test conditions

#	Item	Parameter		
1	UE output power	Min = +15.0 dBm, Max = +23.0 dBm		
2	UE operating band	E-UTRA Band 19		
3	Channel bandwidth	5MHz	10MHz	15MHz
4	Carrier Frequency	842.5MHz	840.0MHz	837.5MHz
5	Modulation	QPSK, 16QAM		
6	Position of RBs	Upper Edge of the Tx band		

6.4.1.2 Outline of Evaluation results

6.4.1.2.1 Brief overview of measurement results

To confirm the validities of the measurement results, we look at the spurious emissions generated by full RBs allocation for 10MHz and 15MHz Channel bandwidth respectively for Band 19 illustrated in Figure 6.4.1.2.1-1 and 6.4.1.2.1-2. From the results, it can be seen that for full RBs allocation of 15MHz Channel bandwidth as well as 10MHz Channel bandwidth, some power reductions in addition to MPR are needed to satisfy the spurious emission requirements. It should be also noted that for full RBs allocation for 15MHz Channel bandwidth, if the allocation is shift toward 15MHz lower, i.e., the transmission band of Band 18, no power reduction is needed since the PSD decreases by around 20dB for the range $865 \text{ MHz} \leq f \leq 875 \text{ MHz}$ in Figure 6.4.1.2.1-2. It should be noted that any implementation margins are not incorporated in these two figures.

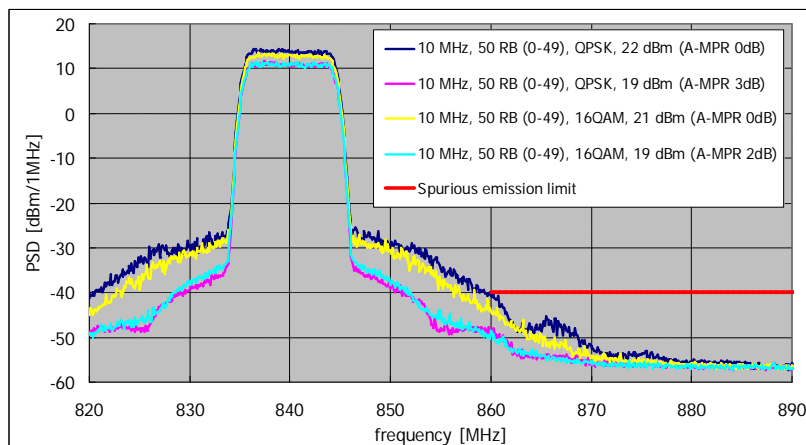

Figure 6.4.1.2.1-1: Spurious emission for 50RBs (10MHz Channel bandwidth and QPSK or 16QAM)

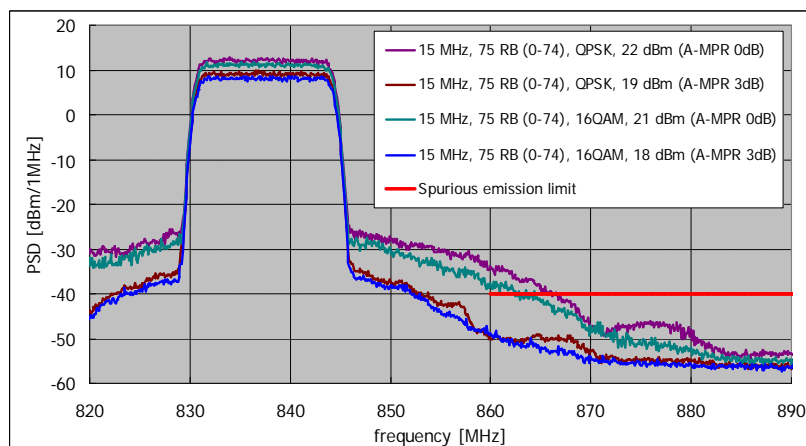

Figure 6.4.1.2.1-2: Spurious emission for 75RBs (15MHz Channel bandwidth and QPSK or 16QAM)

6.4.1.2.2 for 5MHz Channel bandwidth cases

Figure 6.4.1.2.2-1 and 6.4.1.2.2-2 show the maximum leakage interference power in Rx band for each RB allocation in case of 5MHz channel bandwidth. From the results, it can be seen that for all the combinations of modulation and number of RBs, the spurious emission requirement -40 dBm/1MHz is satisfied without any power reduction. Therefore, no A-MPR is needed to be defined for 5MHz Channel bandwidth.

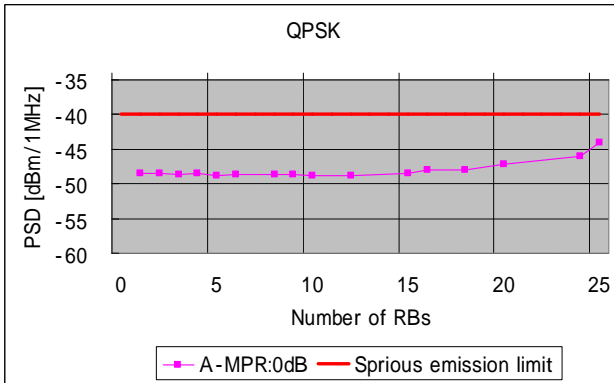

Figure 6.4.1.2.2-1 spurious levels for QPSK

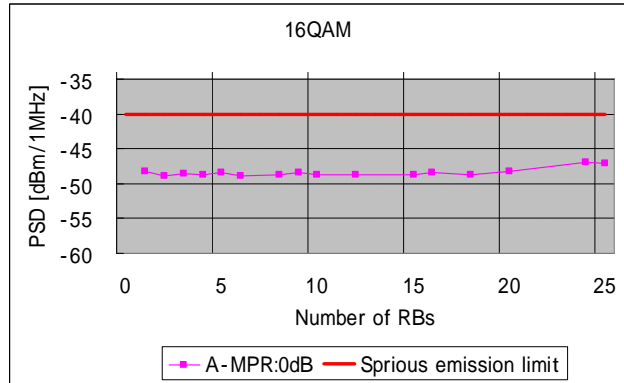

Figure 6.4.1.2.2-2 spurious levels for 16QAM

6.4.1.2.3 for 10MHz and 15MHz Channel bandwidth cases

Figure 6.4.1.2.3-1 to 6.4.1.2.3-4 show the evaluation results in case of 10 MHz and 15 MHz channel bandwidths. From the results, it can be observed that some Additional Power Reductions are needed to satisfy the spurious emission requirements. Based on the results, the necessary A-MPRs to satisfy the spurious emissions requirements are derived by investigating the boundary number of RBs for which the required A-MPR value changes. In each Figure, the boundary line A(yellow), B(purple) and C(blue) show the start points where from each point, A-MPR=1, 2 and 3dB may be allowed to used to meet the spurious emission requirements respectively in the following ways.

- From the boundary line A(yellow), A-MPR of 1 dB would be applied.
- From the boundary line B(purple), A-MPR of 2 dB would be applied.
- From the boundary line C(blue), A-MPR of 3 dB would be applied.

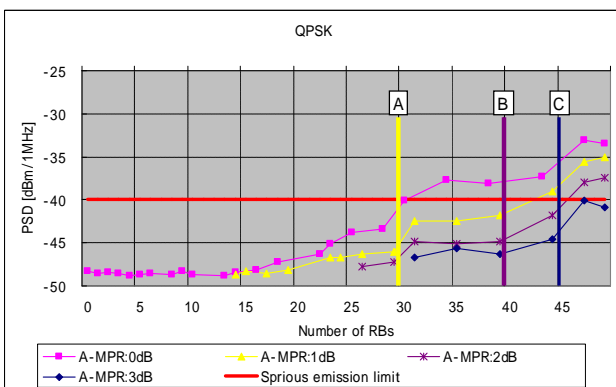

Figure 6.4.1.2.3-1 spurious levels (10MHz CBW and QPSK)

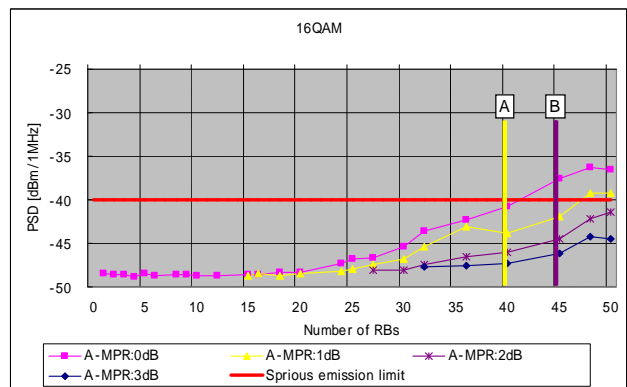

Figure 6.4.1.2.3-2 spurious levels (10MHz CBW and 16QAM)

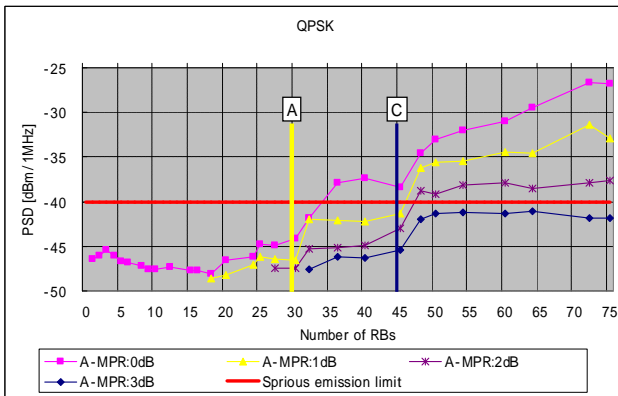

Figure 6.4.1.2.3-3 spurious levels (15MHz CBW and QPSK)

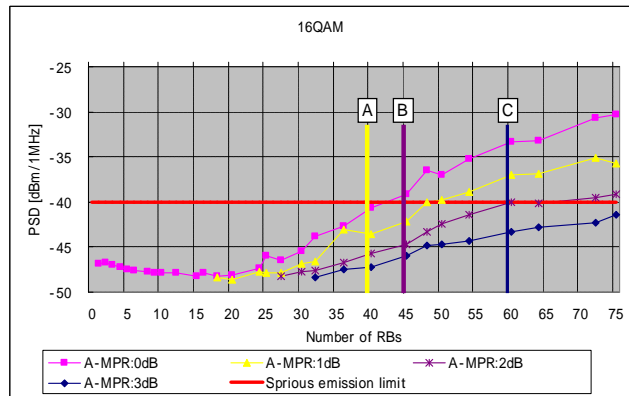

Figure 6.4.1.2.3-4 spurious levels (15MHz CBW and 16QAM)

6.4.1.3 Summary of results

Based on the evaluation results reported in Figure 6.4.1.3-1 to 6.4.1.3-2, the required minimum A-MPR for each combination, number of RBs and Channel bandwidth can be obtained and summarized in table 6.4.1.3-1. It should be also noted that these results are well aligned with [12].

Table 6.4.1.3-1 Additional Maximum Power Reduction (A-MPR)

Network Signalling value	Requirements (sub-clause)	E-UTRA Band	Channel bandwidth (MHz)	Resources Blocks	A-MPR (dB)
NS_[08]	6.6.3.3.3	19	10, 15	>29 for QPSK	≤ 1
				>39 for 16QAM	
			10	>39 for QPSK	≤ 2
			10, 15	>44 for 16QAM	
			10, 15	>44 for QPSK	≤ 3
15	>59 for 16QAM				

Finally, the above table is further summarized as shown Table 6.4.1.3-2.

Table 6.4.1.3-2 Additional Maximum Power Reduction (A-MPR)

Network Signalling value	Requirements (sub-clause)	E-UTRA Band	Channel bandwidth (MHz)	Resources Blocks	A-MPR (dB)
NS_[08]	6.6.3.3.3	19	10, 15	> 29	≤ 1
				> 39	≤ 2
				> 44	≤ 3

6.4.2 Spurious emissions

This section shows the spurious emission requirements for E-UTRA Band 18 and Band 19.

6.4.2.1 Minimum requirements

The general spurious emission requirements for Band 18 and Band 19 UEs are the same for other bands.

6.4.2.2 Spurious emission band UE co-existence

In Japan, the technical conditions for the effective use of mobile commercial-use frequencies for LTE and other next generation communication systems had been investigated by the Study Group to Examine Expanded Use of Frequency Bands for Mobile Service [7]. The technical conditions for extended LTE 800 had also been investigated and by considering the operation in 15MHz channel bandwidth for Band 18 and Band 19 and the corresponding traffic increase, the spurious emission limit for extended LTE 800 was introduced as regulation as follows.

For the frequency range $860 \text{ MHz} \leq f \leq 895 \text{ MHz}$,

the required spurious emission limit for the protection of LTE UE receiver band is $-40\text{dBm}/1\text{MHz}$.

In addition, the downlinks of Band 1, 9, 11, 34 and PHS protection band also need protection from both Band 18 and Band 19 UEs. Therefore additional entries should be introduced as shown in Table 6.4.2.2-1.

Table 6.4.2.2-1 Spurious emission requirement for extended LTE 800

E-UTRA Band	Spurious emission						
	Protected band	Frequency range (MHz)			Level (dBm)	Bandwidth (MHz)	Comment
6	E-UTRA Band 1, 9, 11, 34	FDL_low	-	FDL_high	-50	1	
	Frequency range	860	-	875	-37	1	
	Frequency range	875	-	895	-50	1	
	Frequency range	1884.5	-	1919.6	-41	0.3	
18	E-UTRA Band 1, 9, 11, 34	FDL_low	-	FDL_high	-50	1	
	Frequency range	860	-	895	-40	1	
	Frequency range	1884.5	-	1919.6	-41	0.3	
	Frequency range	860	-	895	-40	1	
19	E-UTRA Band 1, 9, 11, 34	FDL_low	-	FDL_high	-50	1	
	Frequency range	860	-	895	-40	1	
	Frequency range	1884.5	-	1919.6	-41	0.3	

6.4.2.3 Additional spurious emissions

Though Japanese law does not clearly mention the frequency range $860 \text{ MHz} \leq f \leq 865 \text{ MHz}$, i.e. OOB domain which occurs if Band 19 is operated in the 15MHz channel bandwidth, for co-existence between Band 18 and Band 19, the OOB domain necessarily has to be protected [5]. Therefore, the additional spurious emission requirement should be specified for the frequency range $860 \text{ MHz} \leq f \leq 895 \text{ MHz}$. From the frequency allocation, this additional requirement will only need to be specified for Band 19.

Therefore when "NS_[08]" is indicated in the cell, the power of any UE spurious emission shall not exceed the level specified in Table 6.4.2.3-1. The A-MPR to meet this requirement is for further study.

Table 6.4.2.3-1 Additional requirement for extended LTE 800

Frequency band (MHz)	Channel bandwidth / Spectrum emission limit (dBm)			Measurement bandwidth
	5MHz	10MHz	15MHz	
$860 \leq f \leq 895$	-40	-40	-40	1 MHz

6.4.3 Reference sensitivity power level

6.4.3.1 Direction of investigation for LTE

The details of the extended Band 18 and Band 19 are described in Figure 6.4.3.1-1. It should be noted that they have the same pass bandwidth and duplex gap. As the reference sensitivity mostly depends on the difference in pass bandwidth and duplex gap, we assume that the same reference sensitivity could be applied for both Band 18 and Band 19.

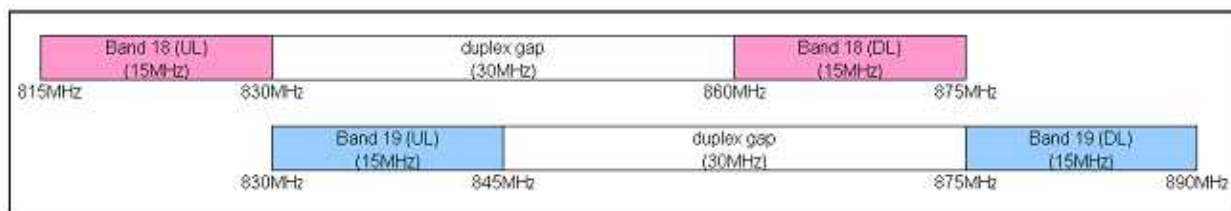

Figure 6.4.3.1-1 Frequency arrangement for new Bands

6.4.3.2 Evaluation of the reference sensitivity of Band 18 and Band 19 for LTE

The section 5.4.2 shows that the reference sensitivity of Band XIX for UMTS is the same as that of Band VI. Therefore, we propose to apply the same reference sensitivity requirement of Band 6 for Band 19 in the case 5MHz and 10MHz channel bandwidth. Reference sensitivity power levels for the 15 MHz Channel bandwidths could be derived by scaling according to the number of resource blocks.

The same requirement can be applied to Band 18 as both bands have the same pass bandwidth and duplex gap.

6.4.3.3 Proposal of reference sensitivity of Band 18 and Band 19 for LTE

According to the evaluation in section 6.4.3.2, the proposed requirements for TS36.101 are summarized in Table 6.4.3.3-1.

Table 6.4.3.3-1 Reference sensitivity QPSK P_{REFSENS}

E-UTRA Band	Channel bandwidth						Duplex Mode
	1.4 MHz (dBm)	3 MHz (dBm)	5 MHz (dBm)	10 MHz (dBm)	15 MHz (dBm)	20 MHz (dBm)	
1	-	-	-100	-97	-95.2	-94	FDD
6	-	-	-100	-97	-	-	FDD
18	-	-	-100	-97	-95.2	-	FDD
19	-	-	-100	-97	-95.2	-	FDD

6.4.3.4 Evaluation of maximum uplink configuration of Band 18 and Band 19 for LTE

The maximum uplink configuration for reference sensitivity for TS36.101 is needed for further study as listed in Table 6.4.3.4-1.

Table 6.4.3.4-1 Maximum uplink configuration for reference sensitivity

E-UTRA Band	Number of RBs for each Channel bandwidth						Duplex Mode
	1.4 MHz	3 MHz	5 MHz	10 MHz	15 MHz	20 MHz	
6	-	-	25	25	-	-	FDD
18	-	-	25	25	25	-	FDD
19	-	-	25	25	25	-	FDD

6.4.4 Blocking characteristics

6.4.4.1 In band blocking

In-band blocking for LTE 800 (both Band 18 and Band 19) should apply the same requirements for other band.

6.4.4.2 Out of band blocking

Out of band blocking for LTE 800 (both Band 18 and Band 19) should apply the same requirements for other band.

6.5 E-UTRA Band 6 handling

The frequency arrangement of Band 6 and Extended LTE 800 (Band 19) is as follows.

- Band 6 : 830-840MHz(UL), 875-885MHz(DL)
- Band 19: 830-845MHz(UL), 875-890MHz(DL)

In Japan, the commercial service in Band VI for UTRA has already been operated, so the Band VI remains handled as ever. On the other hand, there are no plans for the commercial service in Band 6 to be operated at least in Japan due to use Band 19 for E-UTRA. In this case, it is expected that the maintenances for Band 6 need to be continued in spite of not be in use and the misinterpretation that Band 6 is applicable like Band VI in Japan occurs. In order to prevent these problems from occurring, two solutions can be imagined that Band 6 is deleted or "Band 6 is not applicable" is added in 3GPP specification where the descriptions on Band 6 are not maintained any longer. The former is seemingly-simple, but it is difficult to predict the risk of influencing other specifications because there is no precedent for this. So, it is assumed that the latter is reasonable. Therefore the following two items are proposed.

Proposal 1 : The descriptions on Band 6 are not updated for the WI TR and the corresponding 3GPP specifications.

Proposal 2 : "Band 6 is not applicable" is added in TS36.101, TS36.104, TS36.141, and TS36.521-1 as shown in Table 6.5-1.

Table 6.5-1 E-UTRA operating bands

E-UTRA Operating Band	Uplink (UL) operating band BS receive UE transmit	Downlink (DL) operating band BS transmit UE receive	Duplex Mode
	F_{UL_low} – F_{UL_high}	F_{DL_low} – F_{DL_high}	
6 ^[1]	830 MHz – 840 MHz	875 MHz – 885 MHz	FDD
18	815 MHz – 830 MHz	860 MHz – 875 MHz	FDD
19	830 MHz – 845 MHz	875 MHz – 890 MHz	FDD

NOTE 1: Band 6 is not applicable.

7 Summary of required changes to UTRA specifications

7.1 Required changes to TS 25.101

Required changes in TS25.101 are shown in Table 7.1-1.

Table 7.1-1 Required Changes for TS25.101

Clause	Description	Description of change
5.2	Frequency band	A new row for the band in the table
5.3	TX-RX frequency separation	A new row for the band in the table
5.4.2	Channel raster	No changes. [100kHz offset]

5.4.3	Channel number	A new channel numbering for the band.
5.4.4	UARFCN	Channel numbering for the band
6.2.1	Max Output Power	Required for regulatory (Same for Band VI)
6.6.2.1	Emission Mask	Required for regulatory (Same for Band VI)
6.6.3	Tx Spurious emissions	Required for regulatory (Same for Band VI) A new row for the band in the table
7.3	Reference sensitivity	Add requirement for Band XIX(Same for Band VI)
7.6	Blocking	Add requirement for Band XIX
7.8	Intermodulation	No changes
7.9	Rx spurious emission	Required for regulatory (Same for Band VI)
B.2.2	Multi-path fading propagation conditions	Add conditions for Band XIX (Same for Band VI)
B.2.6	MIMO propagation conditions	Add conditions for Band XIX (Same for Band VI)
E.2	List of UARFCN used for UTRA FDD bands	Add conditions for Band XIX (Same for Band VI)

7.2 Required changes to TS 25.104

Required changes in TS25.104 are shown in Table 7.2-1.

Table 7.2-1 Required Changes for TS25.104

Clause	Description	Description of change
5.2	Frequency band	A new row for the band in the table
5.3	TX-RX frequency separation	A new row for the band in the table
5.4.2	Channel raster	No changes. [100kHz offset]
5.4.3	Channel number	A new channel numbering for the band.
6.6.2.1	Emission mask	No changes
6.6.3.1.1	Tx Spurious emissions(Category A)	Required for regulatory (Same for Band VI)
6.6.3.2	Protection of BS receiver	Add requirement for Band XIX
6.6.3.3	Co-existence with other systems in the same geographical area	Add requirement for Band XIX
6.6.3.4	Co-existence with co-located and co-sited base stations	Add requirement for Band XIX
6.6.3.5	Co-existence with PHS	Required for regulatory (Same for Band VI)
6.6.3.6	Co-existence with services in adjacent frequency bands	No changes
6.6.3.9	Co-existence with Home BS operating in other bands	Add requirement for Band XIX
6.6.3.x	Co-existence requirements (Other than above)	No changes
7.5	Blocking	Add requirement for Band XIX
7.6	Inter-modulation	No changes
7.7	Rx spurious emission	Required for regulatory (Same for Band VI)
B.2	Multi-path fading propagation conditions	Add conditions for Band XIX (Same for Band VI)
B.5	Multipath fading propagation conditions	Add conditions for Band XIX (Same for Band VI)

7.3 Required changes to TS 25.113

Required changes in TS25.113 are shown in Table 7.3-1.

Table 7.3-1 Required changes for TS25.113

Clause	Description	Description of change
4.5.2	Receiver exclusion band	Add a new line for Band XIX

7.4 Required changes to TS 25.133

Required changes in TS25.133 are shown in Table 7.4-1.

Table 7.4-1 Required changes for TS25.133

Clause	Description	Description of change
8.1.2.6.1	Identification of a new cell	Add requirement for Band XIX.
9.1	Measurement Performance for UE	Add requirement for Band XIX.
A.9.1	Measurement Performance for UE (Normative Annex for Test cases)	Add requirement for Band XIX.

7.5 Required changes to TS 25.141

Required changes in TS25.141 are shown in Table 7.5-1.

Table 7.5-1 Required Changes for TS25.141

Clause	Description	Description of change
3.4.1	Frequency band	A new row for the band in the table
3.4.2	TX-RX frequency separation	A new row for the band in the table
3.5.2	Channel raster	No changes. [100kHz offset]
3.5.3	Channel number	A new channel numbering for the band.
6.5.2.1	Emission mask	No changes
6.5.3.7.1	Tx Spurious emissions (Category A)	Required for regulatory (Same for Band VI)
6.5.3.7.3	Protection of BS receiver	Add requirement for Band XIX
6.5.3.7.4	Co-existence with other systems in the same geographical area	Add requirement for Band XIX
6.5.3.7.5	Co-existence with co-located and co-sited base stations	Add requirement for Band XIX
6.5.3.7.6	Co-existence with PHS	Required for regulatory (Same for Band VI)
6.5.3.7.7	Co-existence with services in adjacent frequency bands	No changes
6.5.3.7.10	Co-existence with Home BS operating in other bands	Add requirement for Band XIX
6.5.3.7.X	Co-existence requirements (Other than above)	No changes
7.5	Blocking	Add requirement for Band XIX
7.6	Inter-modulation	No changes
7.7	Rx spurious emission	Required for regulatory (Same for Band VI)
D.2	Multi-path fading propagation conditions	Add conditions for Band XIX (Same for Band VI)
D.5	Multi-path fading propagation conditions	Add conditions for Band XIX (Same for Band VI)

7.6 Required changes to TS 34.124

Required changes in TS34.124 are shown in Table 7.6-1.

Table 7.6-1 Required changes for TS34.124

Clause	Description	Description of change
4.4	Receiver exclusion band	Add a new line for Band XIX

7.7 Required changes to TS 25.306

Required changes in TS25.306 are shown in Table 7.7-1.

Table 7.7-1 Required changes for TS25.306

Clause	Description	Description of change
4.5.7	RF parameters	Insert the text that UEs that supports Band XIX shall also support Band VI
5.1	Value ranges	Insert the text that UEs that supports Band XIX shall also support Band VI in the line of FDD RF parameters

7.8 Required changes to TS 25.307

Required changes in TS25.307 are shown in Table 7.8-1.

Table 7.8-1 Required changes for TS25.307

Clause	Description	Description of change
X[TBD]	Band XIX independent of release	Add a new section of Band XIX

7.9 Required changes to TS 25.331

Required changes in TS25.331 are shown in Table 7.9-1.

Table 7.9-1 Required changes for TS25.331

Clause	Description	Description of change
10.3.3.21 a	Measurement capability extension	Define a new value of Band XIX
10.3.3.42 a	UE radio access capability extension	Define a new value of Band XIX
10.3.6.35 c	Frequency band indicator	Define a new value of Band XIX

7.10 Required changes to TS 25.461

Required changes in TS25.461 are shown in Table 7.10-1

Table 7.10-1 Required changes for TS25.461

Clause	Description	Description of change
4.3.7	New operating band introduction	Introduction of new bands for FDD and TDD both in UTRA and E-UTRA in table 4.3.7.1

7.11 Required changes to TS 25.466

Required changes in TS25.466 are shown in Table 7.11-1.

Table 7.11-1 Required changes for TS25.466

Clause	Description	Description of change
Annex B	Antenna operating band field extension for RETAP and TMAAP	- Antenna operating band field is extended in a backward compatible manner

7.12 Required changes to TS 34.108

Required changes in TS 34.108 are shown in Table 7.12-1.

Table 7.12-1 Required changes for TS 34.108

Clause	Description	Description of change
5.1.1.19	Test frequencies	Add a new table for FDD reference test frequencies for Operating Band XIX

7.13 Required changes to TS 34.121-1, TS34.121-2

Required changes in TS 34.121-1 are shown in Table 7.13-1.

Table 7.13-1 Required Changes for TS 34.121-1

Clause	Description	Description of change
4.2	Frequency band	Add a new row for the band in the table
4.3	TX-RX frequency separation	Add a new row for the band in the table
4.4.3	Channel number	Add a new channel numbering for the band.
4.4.4	UARFCN	Add channel numbers for the band
5.2	Max Output Power	Add minimum requirement and test requirement for Band XIX (same as Band VI)
5.4.1	Open Loop Power Control in the Uplink	Add band XIX in the test parameter table of the test case
5.11	Tx Spurious emissions	Add minimum requirement and test requirement for Band XIX (same as Band VI)
6.2	Reference sensitivity	Add minimum requirement and test requirement for Band XIX (same as Band VI)
6.5	Blocking Characteristics	Add minimum requirement and test requirement for Band XIX
6.8	Rx spurious emission	Add minimum requirement and test requirement for Band XIX (same as Band VI)
8.2.3	UTRAN to GSM Cell Re-Selection	Add requirement for Band XIX.
8.3.4	Inter-system Handover from UTRAN FDD to GSM	Add requirement for Band XIX.
8.3.5.3	Cell Reselection to GSM	Add requirement for Band XIX.
8.3.6.3	Cell re-selection during an MBMS session	Add requirement for Band XIX.
8.6.4	GSM measurements	Add requirement for Band XIX.

8.6.5	Combined Interfrequency and GSM measurements	Add requirement for Band XIX.
8.7	Measurements Performance Requirements	Add requirement for Band XIX into related test cases
D.2.2	Multi-path fading propagation conditions	Add conditions for Band XIX (Same for Band VI)
D.2.9	MIMO propagation conditions	Add conditions for Band XIX (Same for Band VI)

Required changes in TS 34.121-2 are shown in Table 7.13-2.

Table 7.13-2 Required changes for TS 34.121-2

Clause	Description	Description of change
A.4.3	Implementation Capabilities	Add new lines for Band XIX

7.14 Required changes to TS 34.123-1, TS 34.123-2, TS 34.123-3

Required changes in TS 34.123-1 are shown in Table 7.14-1.

Table 7.14-1 Required changes for TS 34.123-1

Clause	Description	Description of change
6	Idle mode operations	Add a new line for Band XIX in Table 6.3

Required changes in TS 34.123-2 are shown in Table 7.14-2.

Table 7.14-2 Required changes for TS 34.123-2

Clause	Description	Description of change
A.4.3.2	Implementation Capabilities	Add a new line for Band XIX in Table A.15

8 Summary of required changes to E-UTRA specifications

8.1 Required changes to TS 36.101

Required changes in TS36.101 are shown in Table 8.1-1.

Table 8.1-1 Required Changes for TS36.101

Clause	Description	Description of change
5.5	Frequency band (Operating bands)	A new row for the bands (Band 18 and 19) in the table
5.6.1	Channel bandwidth	A new row for the bands in the table
5.7.3	Channel number (EARFCN)	A new channel numbering for the bands.
5.7.4	TX-RX frequency separation	A new row for the band in the table
6.2.2	Max Output Power	Required for regulatory

		A new row for the band in the table
6.2.4	Max power with additional requirements	Add requirements for Band 19
6.6.2.1	Emission Mask	Required for regulatory
6.6.3	Tx Spurious emissions	Required for regulatory Add requirements for the bands (Band 18 and 19)
7.3	Reference sensitivity	Add requirements for the bands (Band 18 and 19)
7.6	Blocking	Add requirement for the bands
7.8	Intermodulation	No changes
7.9	Rx spurious emission	Required for regulatory

8.2 Required changes to TS 36.104

Required changes in TS36.104 are shown in Table 8.2-1.

Table 8.2-1 Required Changes for TS36.104

Clause	Description	Description of change
5.3	Frequency bands	A new row for the bands (Band 18 and 19) in the table
5.4.3	Channel number	A new channel numbering for the bands.
6.6.3	Operating band unwanted emissions	Required for regulatory
6.6.4.1	Tx Spurious emissions(Cat. A)	Required for regulatory (Same for Band 6)
6.6.4.3	Additional spurious emissions	Add requirements for the bands
6.6.4.4	Co-location with other BS	Add requirements for the bands
6.7	Inter-modulation	No changes
7.6	Blocking	Add requirement for the bands
7.7	Rx spurious emission	Required for regulatory (Same for Band 6)
7.8	Receiver Inter-modulation	No changes

8.3 Required changes to TS 36.113

Required changes in TS36.113 are shown in Table 8.3-1.

Table 8.3-1 Required changes for TS36.113

Clause	Description	Description of change
4.5.2	Receiver exclusion band	Add new lines for the bands (Band 18 and 19)

8.4 Required changes to TS 36.124

Required changes in TS36.124 are shown in Table 8.4-1.

Table 8.4-1 Required changes for TS36.124

Clause	Description	Description of change
4.4	Receiver exclusion band	Add new lines for the bands (Band 18 and 19)

8.5 Required changes to TS 36.133

Required changes in TS36.133 are shown in Table 8.5-1.

Table 8.5-1 Required changes for TS36.133

Clause	Description	Description of change
4.2.2.3	Measurements of intra-frequency E-UTRAN cells	Add requirements for the bands (Band 18 and 19).
4.2.2.4	Measurements of inter-frequency E-UTRAN cells	Add requirements for the bands (Band 18 and 19).
8.1.2.2	E-UTRAN intra frequency measurements	Add requirements for the bands (Band 18 and 19).
8.1.2.3	General Measurement Requirements	Add requirements for the bands (Band 18 and 19).
9.1	E-UTRAN Measurements	Add requirements for the bands.
A.9	Measurement Performance Requirements	Add requirements for the bands.

8.6 Required changes to TS 36.141

Required changes in TS36.141 are shown in Table 8.6-1.

Table 8.6-1 Required Changes for TS36.141

Clause	Description	Description of change
5.5	Operating bands	A new row for the bands (Band 18 and 19) in the table
5.7.3	Channel number	A new channel numbering for the bands.
6.6.3	Operating band unwanted emissions	Required for regulatory
6.6.4.1	Tx Spurious emissions(Cat. A)	Required for regulatory (Same for Band 6)
6.6.4.5.4	Additional spurious emissions	Add requirements for the bands
6.6.4.5.5	Co-location with other BS	Add requirements for the bands
6.7	Inter-modulation	No changes
7.6	Blocking	Add requirement for the bands
7.7	Rx spurious emission	Required for regulatory (Same for Band 6)
7.8	Receiver Inter-modulation	No changes

8.7 Required changes to TS 36.331

No required changes since there is no band specific requirement.

8.8 Required changes to TS 36.508

Required changes in TS 36.508 are shown in Table 8.8-1.

Table 8.8-1 Required changes for TS 36.508

Clause	Description	Description of change
4.3.1.1	FDD Mode Test frequencies	Add new tables for FDD reference test frequencies for band 18 and 19

8.9 Required changes to TS 36.521-1, TS 36.521-2, TS 36.521-3

Required changes in TS 36.521-1 are shown in Table 8.9-1.

Table 8.9-1 Required Changes for TS 36.521-1

Clause	Description	Description of change
5.2	Frequency band (Operating bands)	Add new rows for the bands (Band 18 and 19) in the table
5.3	TX–RX frequency separation	Add new rows for the bands (Band 18 and 19) in the table
5.4.2	Channel bandwidth	Add new rows for the bands (Band 18 and 19) in the table
5.4.4	Carrier frequency and EARFCN	Add new rows for the bands (Band 18 and 19) in the table
6.2.2	Max Output Power	Add minimum requirement and test requirement for the new bands (Band 18 and 19)
6.2.4	Additional Maximum Power Reduction (A-MPR)	Add minimum requirement and test requirement for band 19 (NS_08)
6.6.3.2	Spurious emission band UE co-existence	Add minimum requirement and test requirement for the new bands (Band 18 and 19)
6.6.3.3	Additional spurious emissions	Add minimum requirement and test requirement for band 19 (NS_08)
7.3	Reference sensitivity	Add minimum requirement and test requirement for the new bands (Band 18 and 19)
7.6	Blocking characteristics	Add minimum requirement and test requirement for the new bands (Band 18 and 19)

Required changes in TS 36.521-2 are shown in Table 8.9-2.

Table 8.9-2 Required changes for TS 36.521-2

Clause	Description	Description of change
A.4.3	Implementation Capabilities	Add new lines for Band 18 and 19

Required changes in TS 36.521-3 are shown in Table 8.9-3.

Table 8.9-3 Required changes for TS 36.521-3

Clause	Description	Description of change
8.1	E-UTRAN FDD intra frequency measurements	Add requirements for Band 18 and 19 to the related test cases
8.3	E-UTRAN FDD-FDD Inter-frequency Measurements	Add requirements for Band 18 and 19 to the related test cases
9.1	RSRP measurement	Add requirements for Band 18 and 19 to the related test cases
9.2	RSRQ measurement	Add requirements for Band 18 and 19 to the related test cases

8.10 Required changes to TS 36.523-1, TS 36.523-2, TS 36.523-3

There are no changes required for TS 36.523-1, TS 36.523-2, TS 36.523-3 at the current state.

9 Project plan

9.1 Schedule and Work Task Status

Table 9.1-1 summarises the schedule and work task status for Extended UMTS/LTE 800 WI.

Table 9.1-1 Schedule and work task status

Item#	Effort Required	Responsibility	Schedule	Status
1	Provide deployment scenarios for Extended UMTS/LTE 800 MHz in Japan [5]	ARIB ^{*1}	RAN4#49bis	Completed
2	Provide requirements for co-existence with other technologies in Japan [5]	ARIB ^{*1}	RAN4#49bis	Completed
3	Propose necessary changes for the relevant specifications based on the information provided in #2	ARIB ^{*2}	RAN4#49bis	Completed
4.1	Study and check necessary changes for the relevant specifications and collect appropriate information into a TR	RAN4	RAN4#50 - #50bis	Completed
4.2	Generate CRs to update the appropriate specifications and other documents	RAN4	RAN4#50bis - #51	Completed
5	Study any signalling issues related to Extended UMTS/LTE 800	RAN2	RAN2#65 - #66	Completed
6	Study UE conformance testing issues related to Extended UMTS/LTE 800	RAN5	RAN5#42 - #44	Completed

*1: ARIB provided RAN4 outcomes from Telecommunications Council of Japan.

*2: Individual member of ARIB may provide appropriate information or proposals based on studies at Telecommunications Council of Japan.

10 Open issues

None

Annex A: UARFCN numbers

A.1 List of UARFCN used for UTRA FDD bands

The UARFCN numbering scheme detailed in clauses 5.4.3 and 5.4.4 of TS25.101 is summarized for information in Table A.1. The table shows the UARFCN assigned to all UTRA FDD operating bands, starting with the lowest UARFCN and continuing up to the highest one assigned.

Each band may have two table entries, one for the "general" numbers and one for the "additional" ones, as specified in Table 5.2 of TS25.101. The entries in Table A.1 are explained as follows:

Band range: The size of the frequency range for the UTRA FDD band specified in Table 5.0 of TS25.101.

Range res.: The size of the frequency range corresponding to the UARFCN range that has been "reserved" in 3GPP for possible future extensions of the band.

Formula offset: The offset parameter (F_{UL_Offset} or F_{DL_Offset}) in the formula, used to calculate the UARFCN as specified in Clause 5.4.3 of TS25.101.

Assigned/reserved: Indicates the significance of the UARFCN and corresponding frequencies listed as follows:

Start res.	Start of the UARFCN range reserved for the band.
Min.	The lowest UARFCN assigned to the band.
Max.	The highest UARFCN assigned to the band.
End res.	End of the UARFCN range reserved for the band.

N_U, N_D : Uplink and downlink UARFCN.

F_{UL}, F_{DL} : Corresponding uplink and downlink frequencies.

(Add.): Refers to the additional UARFCN (on the 100 kHz raster) as specified in Table 5.1A of TS25.101.

Note that bands V and VI are shown with common entries in Table A.1, since their UARFCN ranges are completely overlapping.

Table A.1: UARFCN used for the UTRA FDD bands

UTRA FDD Band	Band range [MHz]	Range res. [MHz]	Uplink UARFCN				Downlink UARFCN				
			Formula offset F_{UL_Offset} [MHz]	Assigned/Reserved	N_U	F_{UL} [MHz]	Formula offset F_{DL_Offset} [MHz]	Assigned/Reserved	N_D	F_{DL} [MHz]	
II (Add.)	2x60	2x60	1850.1	Start res.		0	1850.1	1850.1	Start res.	400	1930.1
				Min.		12	1852.5		Min.	412	1932.5
				Max.		287	1907.5		Max.	687	1987.5
				End res.		299	1909.9		End res.	699	1989.9
XIX	2x15	2x15	770	Start res.		300	830.0	735	Start res.	700	875.0
				Min.		312	832.4		Min.	712	877.4
				Max.		363	842.6		Max.	763	887.6
				End res.		374	844.8		End res.	774	889.8
XIX (Add.)	2x15	2x15	755.1	Start res.		375	830.1	720.1	Start res.	775	875.1
				Min.		387	832.5		Min.	787	877.5
				Max.		437	842.5		Max.	837	887.5
				End res.		449	844.9		End res.	849	889.9
V and VI (Add.)	2x25 (V) 2x10 (VI)	2x45	670.1	Start res.		700	810.1	670.1	Start res.	925	855.1
				Min. (V)		782	826.5		Min. (V)	1007	871.5
				Min. (VI)		812	832.5		Min. (VI)	1037	877.5
				Max. (VI)		837	837.5		Max. (VI)	1062	882.5
				Max. (V)		862	842.5		Max. (V)	1087	887.5
				End res.		924	854.9		End res.	1149	899.9
III	2x75	2x75	1525	Start res.		925	1710.0	1575	Start res.	1150	1805.0
				Min.		937	1712.4		Min.	1162	1807.4
				Max.		1288	1782.6		Max.	1513	1877.6
				End res.		1299	1784.8		End res.	1524	1879.8
IV	2x45	2x70	1450	Start res.		1300	1710.0	1805	Start res.	1525	2110.0
				Min.		1312	1712.4		Min.	1537	2112.4
				Max.		1513	1752.6		Max.	1738	2152.6
				End res.		1649	1779.8		End res.	1874	2179.8
IV (Add.)	2x45	2x70	1380.1	Start res.		1650	1710.1	1735.1	Start res.	1875	2110.1
				Min.		1662	1712.5		Min.	1887	2112.5
				Max.		1862	1752.5		Max.	2087	2152.5
				End res.		1999	1779.9		End res.	2224	2179.9
VII	2x70	2x70	2100	Start res.		2000	2500.0	2175	Start res.	2225	2620.0
				Min.		2012	2502.4		Min.	2237	2622.4
				Max.		2338	2567.6		Max.	2563	2687.6
				End res.		2349	2569.8		End res.	2574	2689.8
VII (Add.)	2x70	2x70	2030.1	Start res.		2350	2500.1	2105.1	Start res.	2575	2620.1
				Min.		2362	2502.5		Min.	2587	2622.5
				Max.		2687	2567.5		Max.	2912	2687.5
				End res.		2699	2569.9		End res.	2924	2689.9
VIII	2x35	2x35	340	Start res.		2700	880.0	340	Start res.	2925	925.0
				Min.		2712	882.4		Min.	2937	927.4
				Max.		2863	912.6		Max.	3088	957.6
				End res.		2874	914.8		End res.	3099	959.8
X	2x60	2x60	1135	Start res.		2875	1710.0	1490	Start res.	3100	2110.0
				Min.		2887	1712.4		Min.	3112	2112.4
				Max.		3163	1767.6		Max.	3388	2167.6
				End res.		3174	1769.8		End res.	3399	2169.8
X (Add.)	2x60	2x60	1075.1	Start res.		3175	1710.1	1430.1	Start res.	3400	2110.1
				Min.		3187	1712.5		Min.	3412	2112.5
				Max.		3462	1767.5		Max.	3687	2167.5
				End res.		3474	1769.9		End res.	3699	2169.9
XI	2x25	2x25	733	Start res.		3475	1428.0	736	Start res.	3700	1476.0
				Min.		3487	1430.4		Min.	3712	1478.4
				Max.		3587	1450.4		Max.	3812	1498.4
				End res.		3599	1452.8		End res.	3824	1500.8
XII	2x18	2x18	-22	Start res.		3600	698.0	-37	Start res.	3825	728.0
				Min.		3612	700.4		Min.	3837	730.4
				Max.		3678	713.6		Max.	3903	743.6
				End res.		3689	715.8		End res.	3914	745.8
XII	2x18	2x18	-39.9	Start res.		3690	698.1	-54.9	Start res.	3915	728.1

(Add.)				Min.	3702	700.5		Min.	3927	730.5
				Max.	3767	713.5		Max.	3992	743.5
				End res.	3779	715.9		End res.	4004	745.9
XIII	2x10	2x10	21	Start res.	3780	777.0	-55	Start res.	4005	746.0
				Min.	3792	779.4		Min.	4017	748.4
				Max.	3818	784.6		Max.	4043	753.6
XIII (Add.)	2x10	2x10	11.1	End res.	3829	786.8	-64.9	End res.	4054	755.8
				Start res.	3830	777.1		Start res.	4055	746.1
				Min.	3842	779.5		Min.	4067	748.5
XIV	2x10	2x10	12	Max.	3867	784.5	-63	Max.	4092	753.5
				End res.	3879	786.9		End res.	4104	755.9
				Start res.	3880	788.0		Start res.	4105	758.0
XIV (Add.)	2x10	2x10	2.1	Min.	3892	790.4	-72.9	Min.	4117	760.4
				Max.	3918	795.6		Max.	4143	765.6
				End res.	3929	797.8		End res.	4154	767.8
V and VI	2x25 (V) 2x10 (VI)	2x45	0	Start res.	3930	788.1	0	Start res.	4155	758.1
				Min.	3942	790.5		Min.	4167	760.5
				Max.	3967	795.5		Max.	4192	765.5
IX	2x45	2x75	0	End res.	3979	797.9	0	End res.	4204	767.9
				Start res.	4050	810.0		Start res.	4275	855.0
				Min. (V)	4132	826.4		Min. (V)	4357	871.4
II	2x60	2x60	0	Min. (VI)	4162	832.4	0	Min. (VI)	4387	877.4
				Max. (VI)	4188	837.6		Max. (VI)	4413	882.6
				Max. (V)	4233	846.6		Max. (V)	4458	891.6
I	2x60	2x60	0	End res.	4274	854.8	0	End res.	4499	899.8
				Start res.	8550	1710.0		Start res.	9025	1805.0
				Min.	8762	1752.4		Min.	9237	1847.4
II	2x60	2x60	0	Max.	8912	1782.4	0	Max.	9387	1877.4
				End res.	8924	1784.8		End res.	9399	1879.8
				Start res.	9250	1850.0		Start res.	9650	1930.0
I	2x60	2x60	0	Min.	9262	1852.4	0	Min.	9662	1932.4
				Max.	9538	1907.6		Max.	9938	1987.6
				End res.	9549	1909.8		End res.	9949	1989.8
I	2x60	2x60	0	Start res.	9600	1920.0	0	Start res.	10550	2110.0
				Min.	9612	1922.4		Min.	10562	2112.4
				Max.	9888	1977.6		Max.	10838	2167.6
				End res.	9899	1979.8		End res.	10849	2169.8

Annex B: Change history

Change history							
Date	TSG #	TSG Doc.	CR	Rev	Subject/Comment	Old	New
2009-01	RAN4#49bis	R4-090021			TR skeleton		0.0.1
2009-01	RAN4#49bis	R4-090035			Update based on the agreed input documents in RAN4 #49bis	0.0.1	0.1.0
2009-02	RAN4#50	R4-090557			Update based on the agreed input documents in RAN4 #50	0.1.0	0.2.0
2009-03	RAN4#50bis	R4-091065			Update based on the agreed input documents in RAN4 #50bis	0.2.0	0.3.0
2009-05	RAN4#51	R4-091781			Update based on the agreed input documents in RAN4 #51	0.3.0	0.4.0
2009-05	RAN#44	RP-090468			TSG-RAN for information	0.4.0	1.0.0
2009-06	RAN4#51bis	R4-092404			Update based on the agreed input documents in RAN4 #51bis	1.0.0	1.1.0
2009-08	RAN4#52	R4-092764			Update based on the agreed input documents in RAN2#66, RAN5#43-44	1.1.0	1.2.0
2009-09	RAN4#52	R4-093461			Update based on the agreed input documents in RAN3#65 and the contributon which will be provided to RAN#45	1.2.0	1.3.0
2009-09	RAN#45	RP-090749			TSG-RAN for approval	1.3.0	2.0.0
2009-09	RAN#45	RP-090972			TSG-RAN for approval, revision of RP-090749 Update based on the approved input documents in RAN#45	2.0.0	2.1.0
2009-09	RAN#45				Approved version	2.1.0	9.0.0